

Article number: 2310308125ESD

Description: E+G Antistatic base for levelling elements
LV.A-80-14-AS-M8x68-ESD-C

Measures

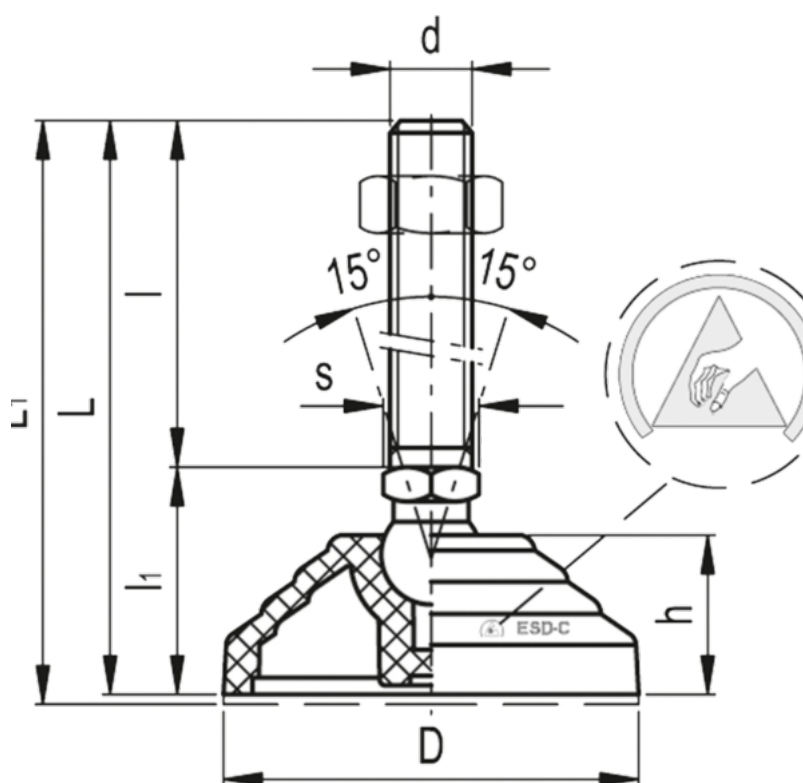

Articulation = 14	Max load = 16000
D = 80	s = 14
d = M8	Weight in (g) = 121
h = 24	
l = 68	
l1 = 33	
L = 101	
L1 = 104	